

REVISION HISTORY					
REV	SHT	DESCRIPTION	DATE	ECN	CHECKED
A	ALL	RELEASE NEW	1/25/05	NEW	JS
B	-	ADDED: ISOMETRIC DWG VIEWS	5/16/05	NEW	DAH
C	-	ADDED: BLACK AND GRAY P/N'S	4/20/10	NEW	JH

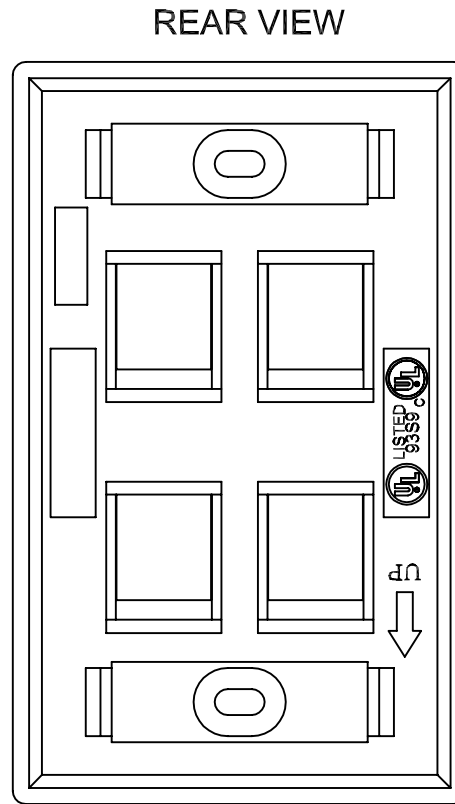

FRONT ISOMETRIC

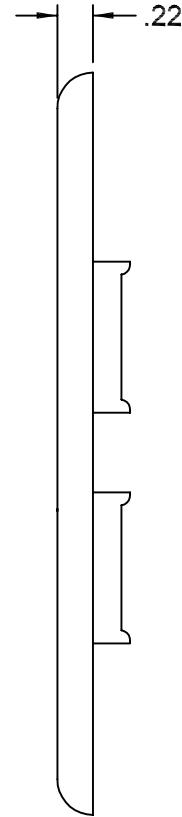
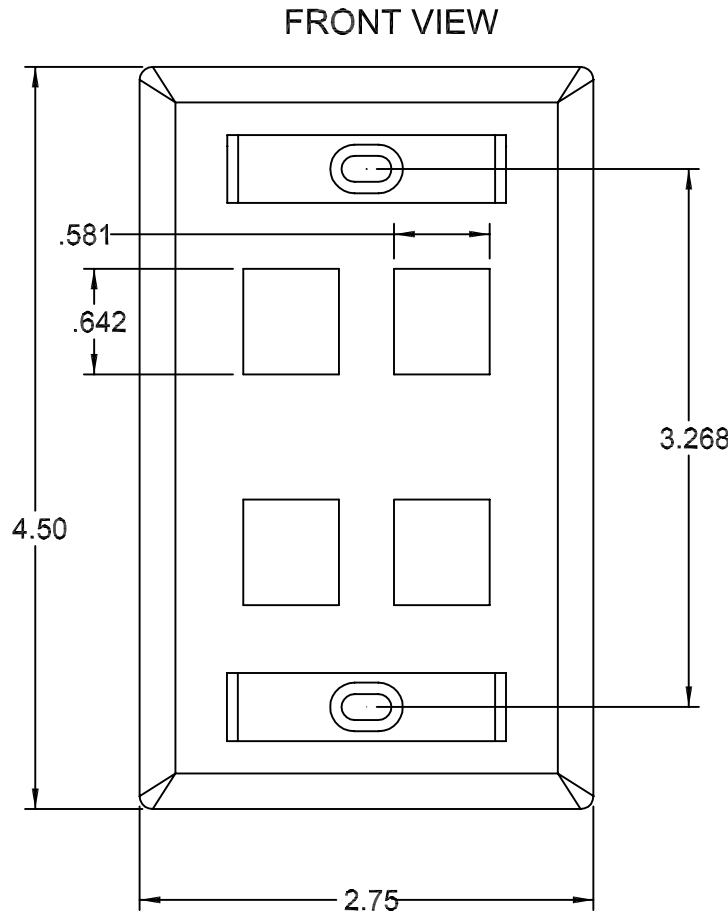
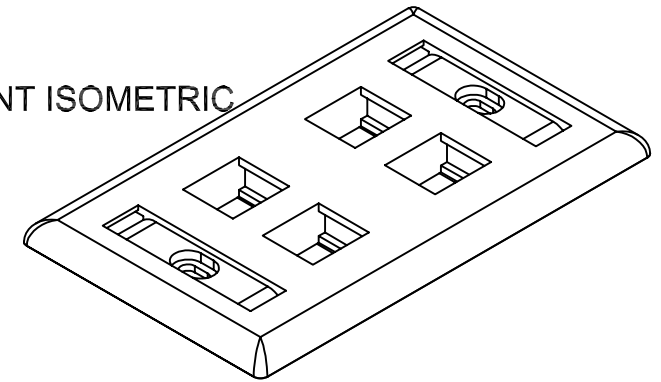

REAR ISOMETRIC

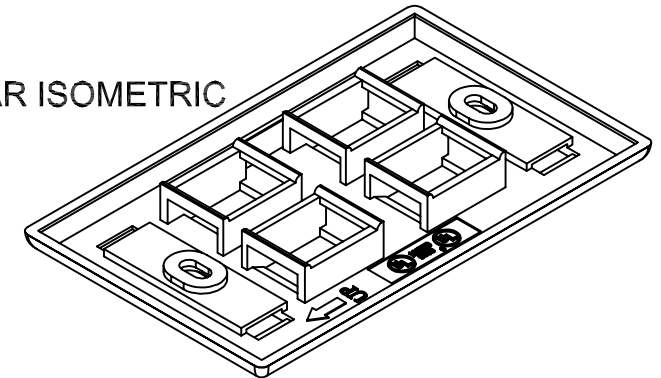

RIGHT SIDE

FPSK0412	FACEPLATE ASSY, SG, FM, KMJ X 4 MTG, BRIGHT WHITE, COMMERCIAL
FPSK0406	FACEPLATE ASSY, SG, FM, KMJ X 4 MTG, GRAY, COMMERCIAL
FPSK0402	FACEPLATE ASSY, SG, FM, KMJ X 4 MTG, BLACK, COMMERCIAL
FPSK0401	FACEPLATE ASSY, SG, FM, KMJ X 4 MTG, OFF. WHITE, COMMERCIAL
FPSK0400	FACEPLATE ASSY, SG, FM, KMJ X 4 MTG, ELEC. IVORY, COMMERCIAL
OCC PART NO.	DESCRIPTION

UNCONTROLLED COPY

UNLESS OTHERWISE SPECIFIED DIMENSIONS ARE IN INCHES.
TOLERANCES: FRACTIONS ±1/32"
ANGLES ±1/2°
3 PLACE DECIMALS ±.005"
2 PLACE DECIMALS ±.01"

THIS DRAWING AND THE DESIGN SHOWN ARE THE PROPERTY OF OPTICAL CABLE CORPORATION AND MAY NOT BE USED AS THE BASIS FOR MANUFACTURE OR SALE WITHOUT SPECIFIC WRITTEN PERMISSION OF OPTICAL CABLE CORPORATION.

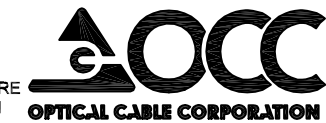

33 Superior Way
Swannanoa, NC 28778
Phone: 828-298-2260
Fax: 828-298-2487
www.occfiber.com

MATERIAL
SEE BILL OF MATERIAL

FINISH
SEE NOTES

DRAWN	E.WETLI	DATE	1/25/05
CHECKED	J.SHERRILL	DATE	5/16/06
ENGINEER	J.YANIK	DATE	1/25/05
APPROVED	J.HOWE	DATE	4/20/10
PREVIOUS DWG			
NEXT DWG		FILENAME	C107117C.DFT

DWG TITLE			
CUSTOMER DRAWING, FACEPLATE ASSEMBLY, SNG GANG, FM, KMJ X 4 MTG			
SIZE	DWG NO.	REV	
B	C107117	C	
SCALE:	NONE	SHEET	1 OF 1

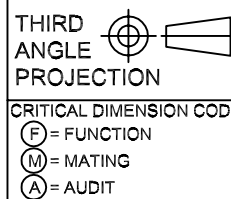

NOTES: UNLESS OTHERWISE SPECIFIED.

1. FACEPLATE ASSEMBLIES ARE PROVIDED WITH (1 each) HARDWARE KIT.