

## Trapezio N°2

Para suspender instalaciones eléctricas,  
de climatización o señalización





# Trapezio N°2

Fijación en un solo canal, ideal para instalaciones de varias alturas. Nuevo diseño para facilitar su instalación.

- Ideal para una rápida suspensión de bandejas portacables, casetes, paneles radiantes...
- Diseñado en forma de cono, se adapta a todas las ranuras
- Discreto. Encaja dentro del carril
- Preajustable en el carril para trabajar cómodamente en altura
- Rápido ajuste
- Estético
- Carga de trabajo de 45 kg, con coeficiente de 5:1
- Disponible como accesorio para instalaciones en varias alturas
- Se suministra en un kit listo para el uso

## Terminaciones disponibles

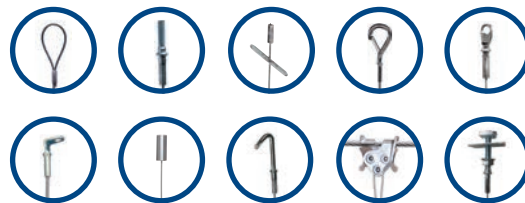

## INFORMACIÓN DE LA ARANDELA

La arandela de seguridad mantiene el trapezio en el carril y facilita el trabajo en altura.





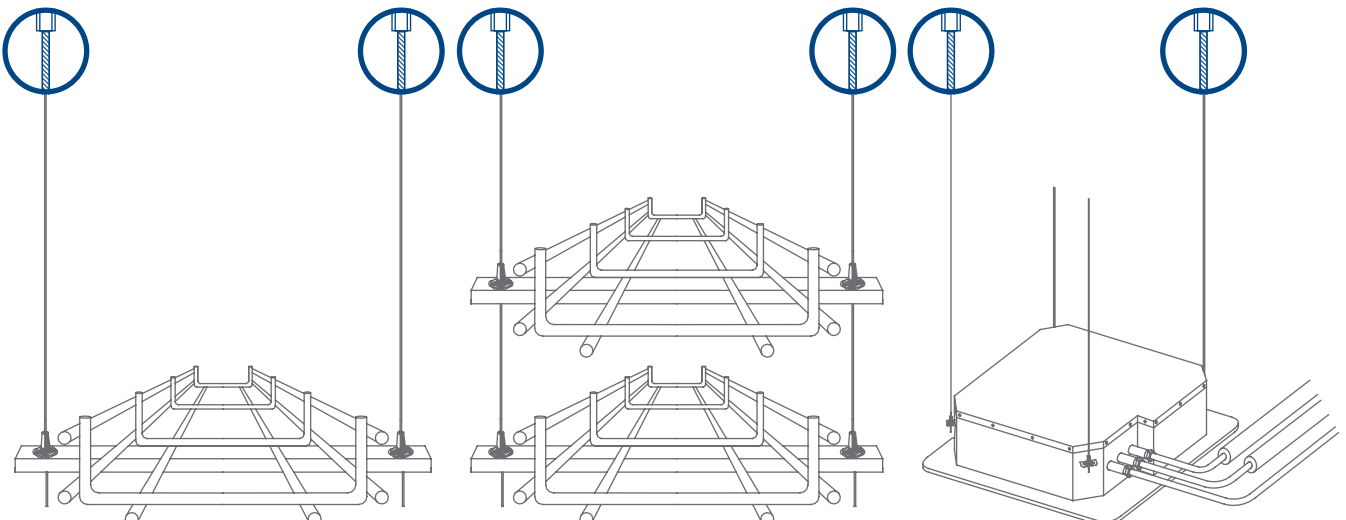

Se instala con una simple presión.









## Instalación



## Código de producto

Terminaciones	Tamaño	Longitud (m)	Nº2 (0 - 45 kg)
 Lazo		1	TPZ21FR
		2	TPZ22FR
		3	TPZ23FR
		4	TPZ24FR
		5	TPZ25FR
		10	TPZ210FR
 Roscada M6		1	TPZ21EF6
		2	TPZ22EF6
		3	TPZ23EF6
		4	TPZ24EF6
		5	TPZ25EF6
		10	TPZ210EF6
 Roscada M8		1	TPZ21EF8
		2	TPZ22EF8
		3	TPZ23EF8
		4	TPZ24EF8
		5	TPZ25EF8
		10	TPZ210EF8
 Roscada M10		1	TPZ21EF10
		2	TPZ22EF10
		3	TPZ23EF10
		4	TPZ24EF10
		5	TPZ25EF10
		10	TPZ210EF10
 Tuerca de carril		1	TPZ21ER8
		2	TPZ22ER8
		3	TPZ23ER8
		4	TPZ24ER8
		5	TPZ25ER8
		10	TPZ210ER8
 Rosca hembra M6		1	TPZ21ET6
		2	TPZ22ET6
		3	TPZ23ET6
		4	TPZ24ET6
		5	TPZ25ET6
		10	TPZ210ET6
 Rosca hembra M8		1	TPZ21ET8
		2	TPZ22ET8
		3	TPZ23ET8
		4	TPZ24ET8
		5	TPZ25ET8
		10	TPZ210ET8

Terminaciones	Taille	Longitud (m)	Nº2 (0 - 45 kg)
 Paragüas		1	TPZ21SP
		2	TPZ22SP
		3	TPZ23SP
		4	TPZ24SP
		5	TPZ25SP
		10	TPZ210SP
 Gancho		1	TPZ21EC
		2	TPZ22EC
		3	TPZ23EC
		4	TPZ24EC
		5	TPZ25EC
		10	TPZ210EC
 Ojal		1	TPZ21EO
		2	TPZ22EO
		3	TPZ23EO
		4	TPZ24EO
		5	TPZ25EO
		10	TPZ210EO
 Ojal 90°		1	TPZ21EO90
		2	TPZ22EO90
		3	TPZ23EO90
		4	TPZ24EO90
		5	TPZ25EO90
		10	TPZ210EO90
 Gancho para techo		1	TPZ21TH
		2	TPZ22TH
		3	TPZ23TH
		4	TPZ24TH
		5	TPZ25TH
		10	TPZ210TH
 C-Clip		1	TPZ21CC6
		2	TPZ22CC6
		3	TPZ23CC6
		4	TPZ24CC6
		5	TPZ25CC6
		10	TPZ210CC6

El trapecio tiene un coeficiente de 5 :1. Otras medidas están disponibles bajo pedido.



**Necesita soportar una mayor carga?**

Utilice nuestro trapecio N°3 con una carga de trabajo de 90kgs y un coeficiente de seguridad de 3:1.

Contacte con nosotros para cualquier duda.



Bandeja portacables



Bandeja portacables



Unidad de aire acondicionado

# www.gripple.com

esinfo@gripple.com



## Gripple Ltd (Sede central)

The Old West Gun Works  
Savile Street East  
Sheffield S4 7UQ  
UK

UK Sales: 0800 018 4264  
Fax: +44 (0)114 275 1155  
Email: info@gripple.com



### Gripple Europe SARL

1, rue du commerce  
BP 37  
67211 Obernai Cedex  
France

T | +33 (0)3 88 95 44 95  
F | +33 (0)3 88 95 08 78  
E | frinfo@gripple.com

### Gripple GmbH

Pariser Ring 1  
76532 Baden-Baden  
Deutschland

T | +49 (0)700 95 44 95 11  
F | +49 (0)700 95 08 78 11  
E | deinfo@gripple.com

### Gripple Inc

1611 Emily Lane  
Aurora  
IL 60502  
USA

T | +1 866 474 7753  
F | +1 800 654 0689  
E | usinfo@gripple.com

### Gripple s.r.l

Via Marconi, 32  
24068 Seriate BG  
Italia

T | +39 (0)35 300 246  
F | +39 (0)35 424 0036  
E | itinfo@gripple.com

### Gripple Benelux

1, rue du commerce  
BP37  
67211 Obernai Cedex  
Frankrijk

T | +31 (0)70 363 34 30  
F | +31 (0)70 362 18 44  
E | nlinfo@gripple.com

### Gripple Industrial Ibérica, S.L.

Ctra. Logroño km 7, 3 Pol. Europa 1  
50011 Zaragoza  
España

T | +34 (0)97 678 32 67  
F | +34 (0)97 678 32 68  
E | esinfo@gripple.com

### Gripple Portugal

Estrada Nacional 4  
Km 46,5 Pontal  
2985-201 Pegões  
Portugal

T | +351 265 898 870  
F | +351 265 898 879  
E | ptinfo@gripple.com

### Gripple Australia / NZ

Polyplas Pty Ltd, 30 Sydney Rd  
Bayswater, Victoria 3153  
Australia

T | +61 (0)3 9720 0449  
F | +61 (0)3 9720 0469  
E | auinfo@gripple.com

© 2011 Gripple

Gripple es una marca registrada de Gripple Limited.

Registrada en Inglaterra N°1772901, TVA N° GB 600 1951 88

BROC-IND-TZ2-SPA